

TV Connectors

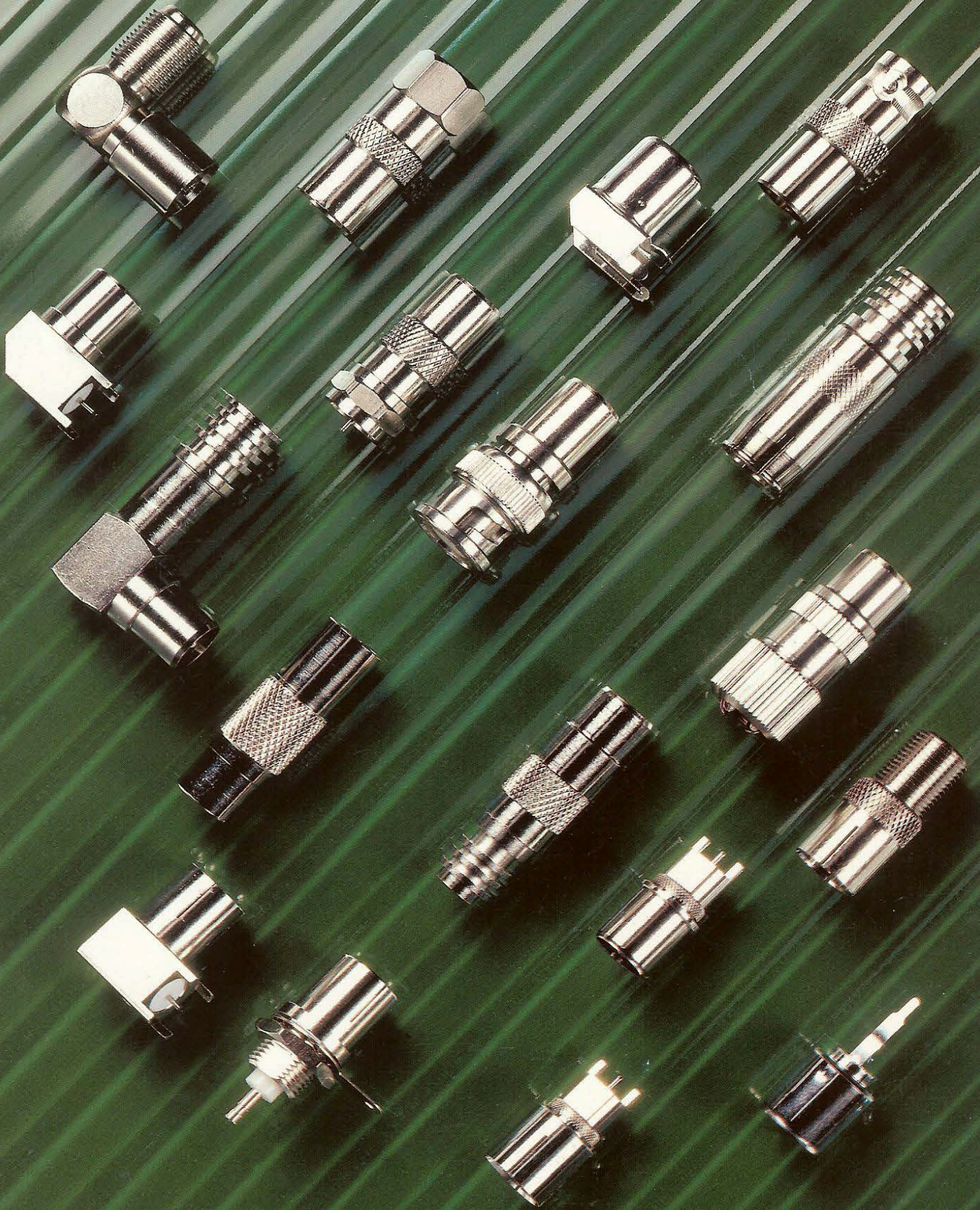

DUPLEX CSA

TV Connectors

Contents

	Page
PCB Mount Connectors	1 - 3
Swage-on-connectors	3
Cable Mount Crimp Connectors	4 - 5
Cable Mount Twist-on Connectors	5
Adaptors	6
Bulkhead Mount Connectors	9

Duplex TV connectors interface with CATV, MATV and Satellite TV installations and are available in the widest range of configurations.

Electrical characteristics

Impedance	Non constant
Operating frequency	0-1 GHz
Voltage rating	250 V rms

Materials

Body including fittings	Nickel plated brass
Insulator	Delrin
Contact	Brass, Phosphor bronze or beryllium copper

Waterproof Versions

All TV connectors can be supplied in waterproof versions. For waterproof version of any TV connector add the suffix W to the relevant part number.

Custom Connectors

Duplex CSA TV connectors can be manufactured in a wide range of plating and fixing styles in relatively low quantities. Our range is ever growing to meet customer requirements. For information on your own design of TV connector contact our sales office.

Fly Lead Assemblies

Duplex CSA are Europe's largest manufacturer of Fly Lead Assemblies, all assemblies are manufactured in the U.K. from piece parts held in stock. This minimises cost and allows fast turnaround of assemblies to customer specification.

We manufacture cable assemblies of any cable length, colour or type, and terminate with any style of connector. Telephone our sales office to discuss any requirements you may have.

PCB Mounting

Circuit Board mounting connectors are available in a variety of configurations. To discuss your requirement contact our sales office.



DUPLEX CSA

DUPLEX CSA LTD
Telephone: +44 (0)1480 406206

TV Connectors

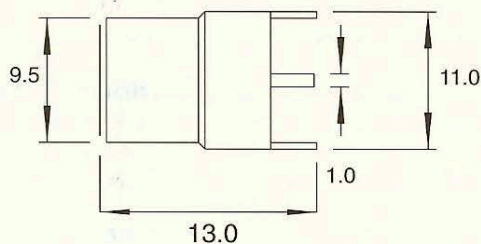
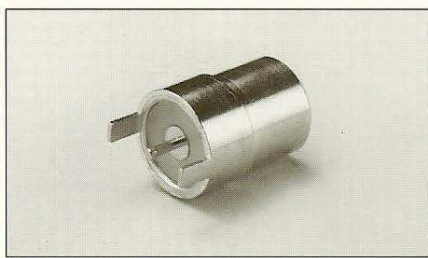

PCB MOUNT CONNECTORS

Part No. DUP-012C
Male - 1.0mm pin.

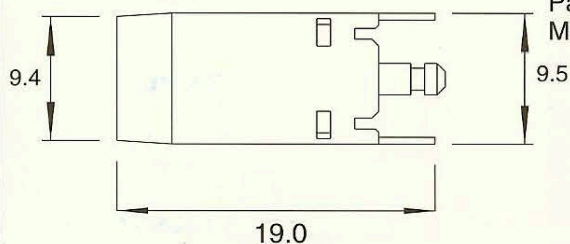

Part No. DUP-011
Male - vertical mount

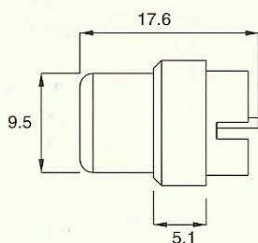

Part No. NED-01
Male - edge mount

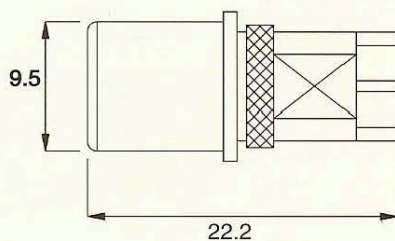
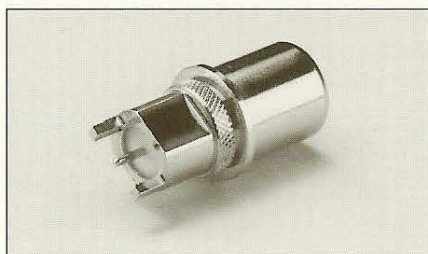

Part No. DIC-12
Male - vertical mount

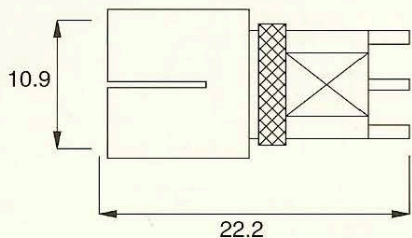
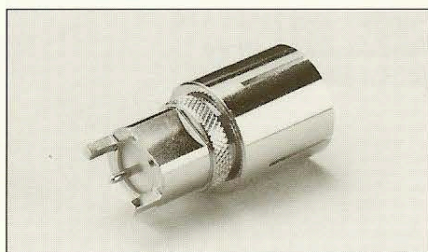

Part No. DIC-14
Female - vertical mount

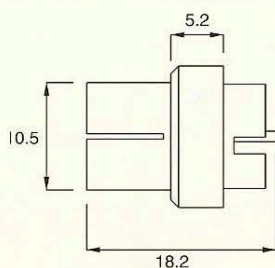

Part No. NED-02
Female - edge mount

TV Connectors

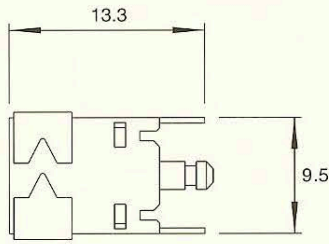
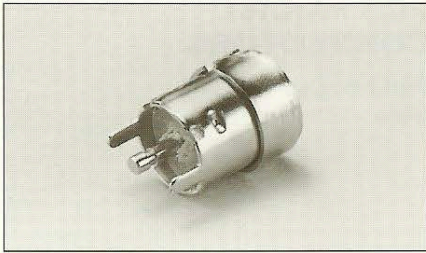

Part No. DUP-010
Female - vertical mount

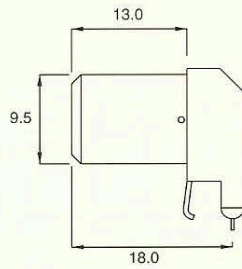
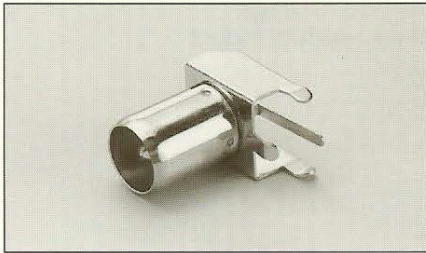

Part No. E-P115R/A
Male - right angle

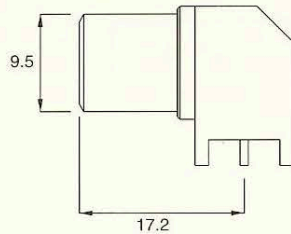
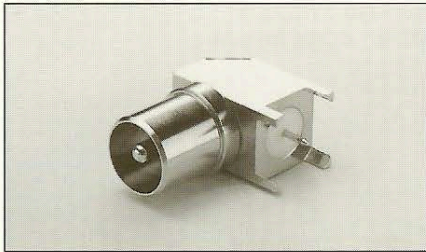

Part No. E-P115R/A-E
Male - right angle

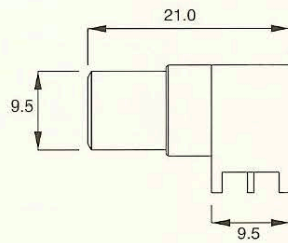
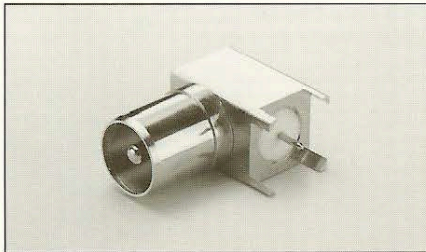

Part No. E-P115R/A-B
Male - right angle
Full Brass

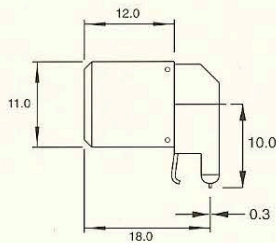
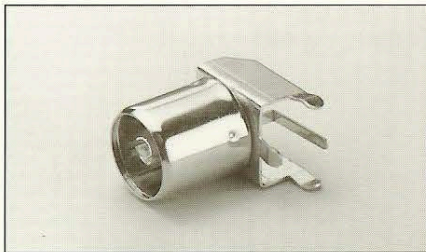

Part No. E-S115R/A10
Female - right angle
10mm pin

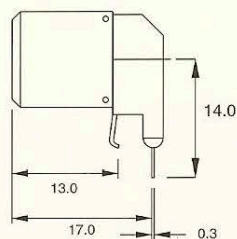
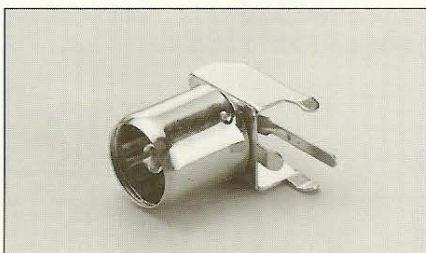

Part No. E-S115R/A
Female - right angle

TV Connectors

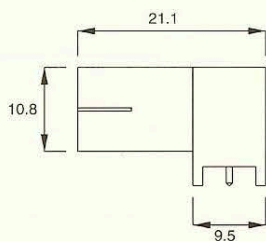
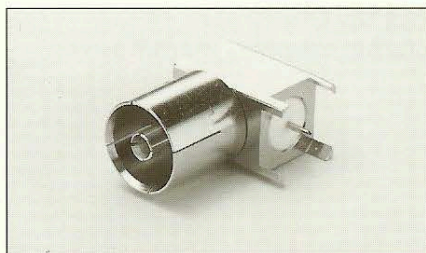

Part No. E-S115R/A-B
Female - right angle
Full Brass

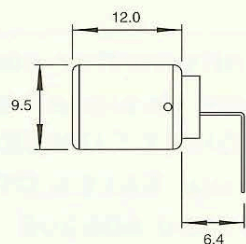

SWAGE-ON CONNECTORS for panel mounting

Part No. TV-204BR/A
Male - right angle

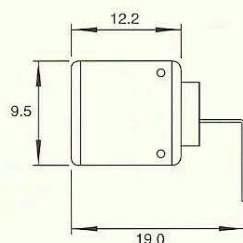

Part No. TV-205BR/A
Female - right angle

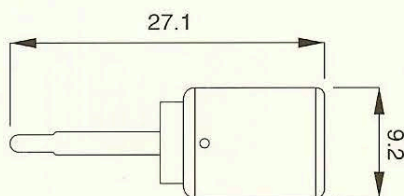

Part No. TV-204B
Male - straight

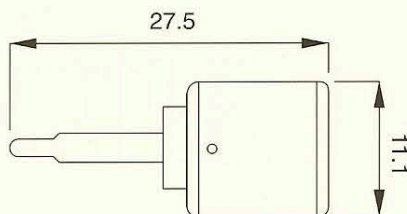

Part No. TV-205B
Female - straight

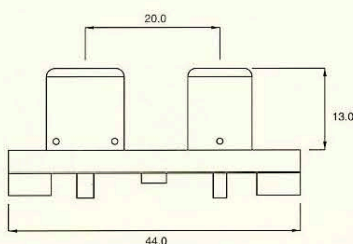
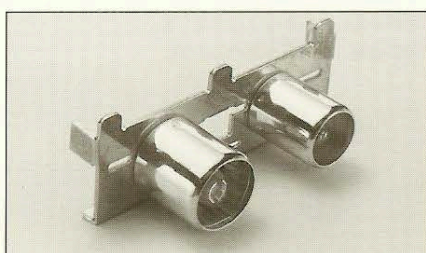

Part No. RWS-01
Edge mount, bracket assembly

TV Connectors

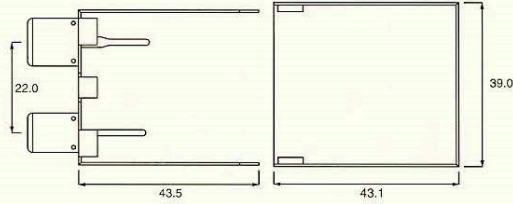
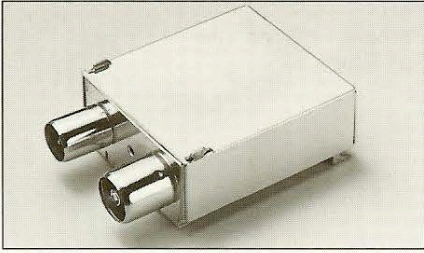

Part No. GUEST-02
Bracket assembly with full screen

**If you require alternative configurations
or need custom designed brackets or
PANEL MOUNT CONNECTORS
Telephone our SALES OFFICE on
Tel: +44(0)1480 406206**

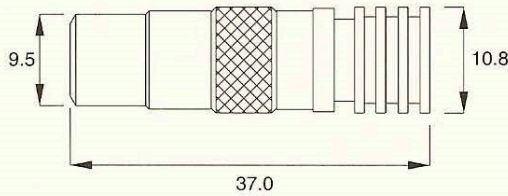
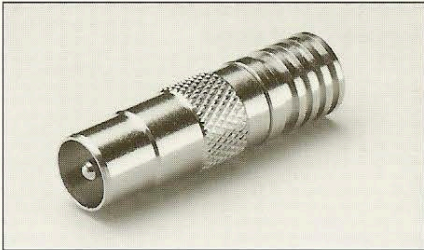

**CABLE MOUNT
CRIMP CONNECTORS**
Part No. ECM-112BG
Male for RG59 cable

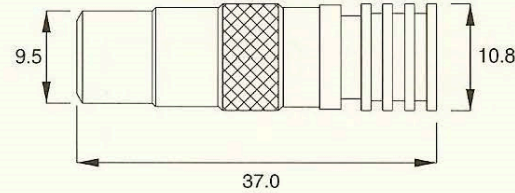
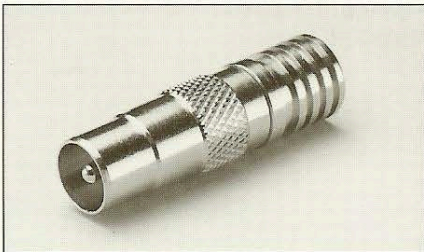

Part No. ECM- 112BA
Male for RG6 cable

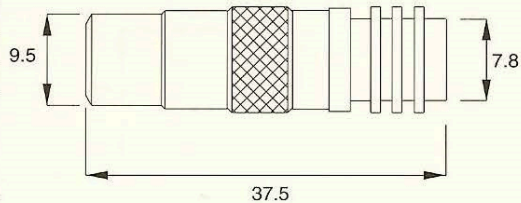

Part No. ECM-112H121
Male for H121 cable

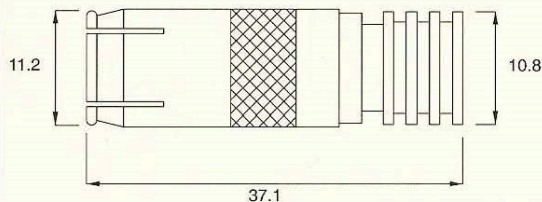

Part No. ECF-212BG
Female for RG59 cable

TV Connectors

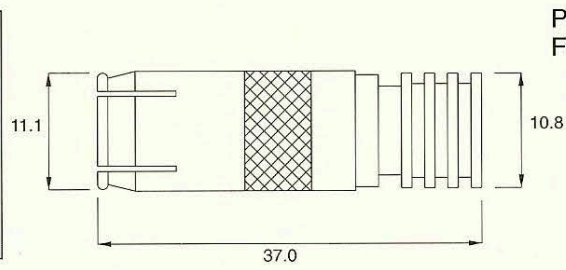
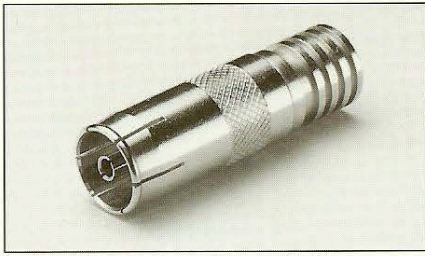

Part No. ECF-212BA
Female for RG6 cable

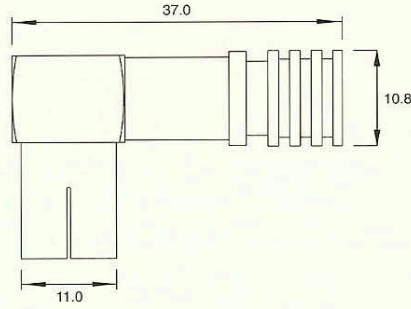
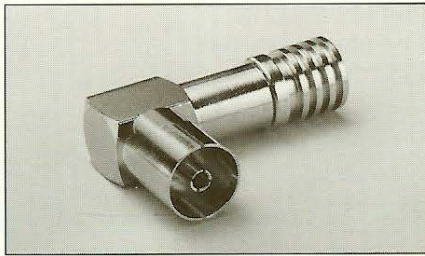

Part No. E-422BG/0.36
Female - right angle for
RG59 cable

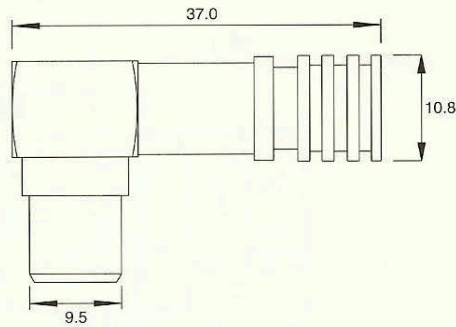
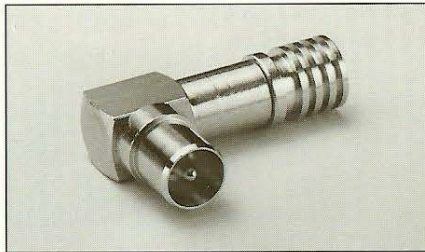

Part No. E-412BG/0.36
Male - right angle for
RG59 cable

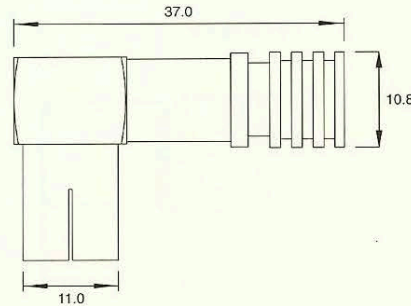
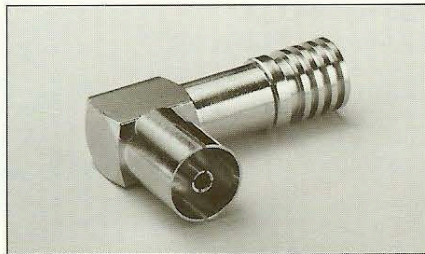

Part No. E-422BA/0.36
Female - right angle for
RG6 cable

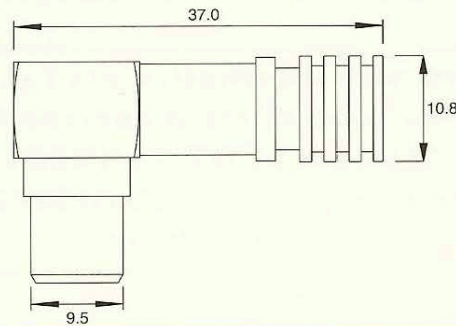
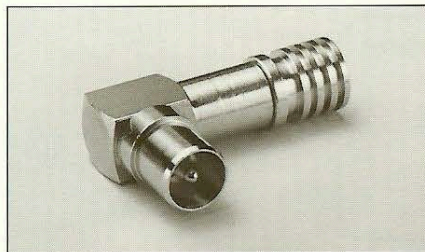

Part No. E-412BA/0.36
Male - right angle for
RG6 cable

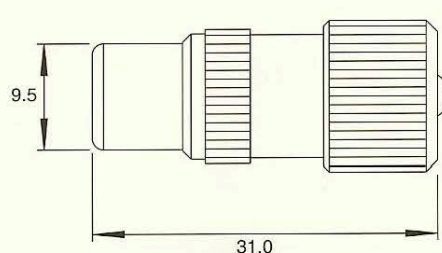

CABLE MOUNT TWIST-ON CONNECTORS

Part No. E-M112
TV Male - all metal

TV Connectors

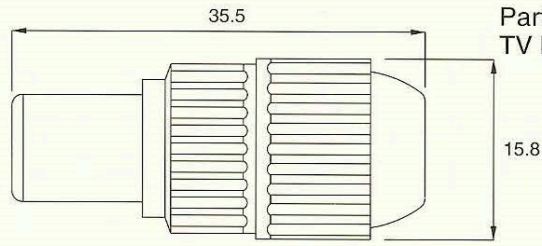
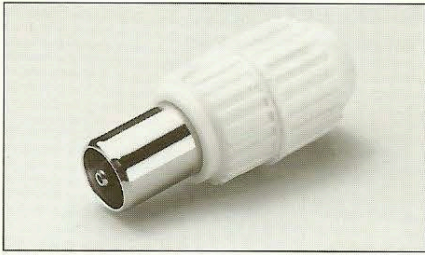

Part No. E-P112
TV Male - plastic

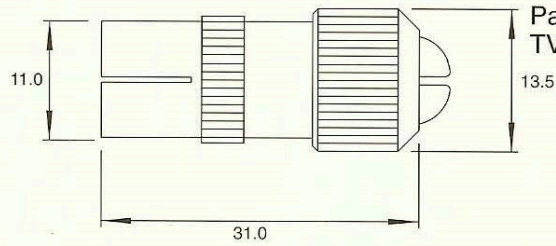
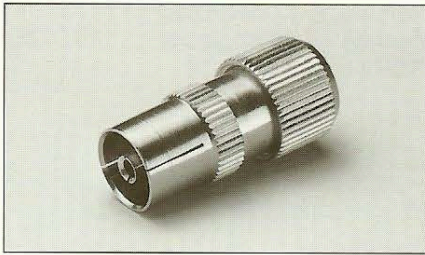

Part No. E-M212
TV Female - all metal

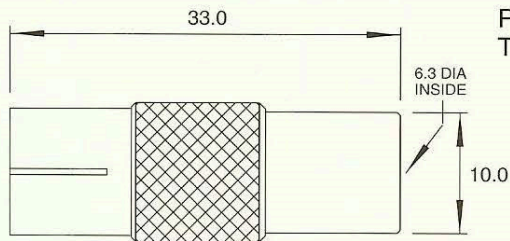
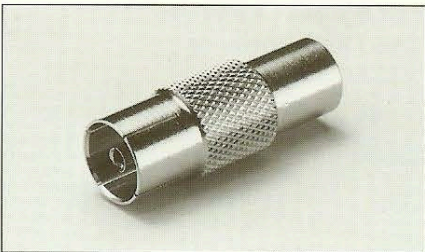

Part No. E-213A
TV Female - RG6

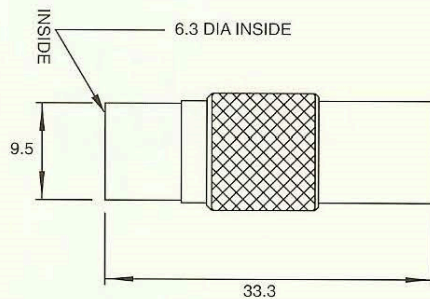
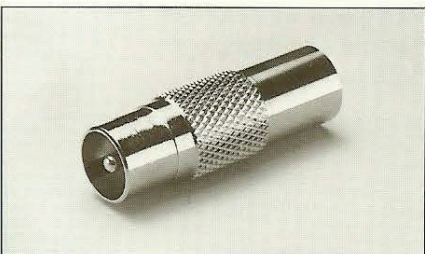

Part No. E-113A
TV Male for RG6 cable

**If you require alternative configurations
or need custom designed
TV CABLE MOUNT CONNECTORS
Telephone our SALES OFFICE on
Tel:+44(0)1480 406206**

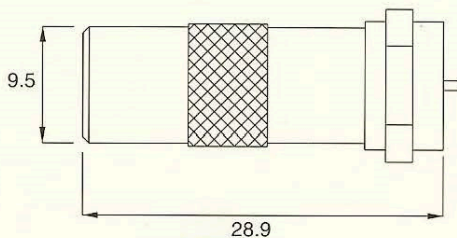
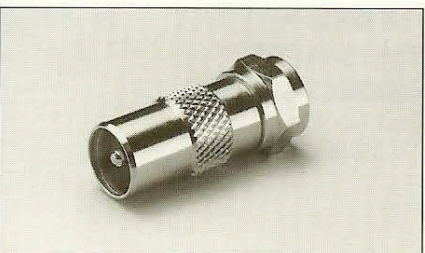

ADAPTORS
Part No. EF-311A
TV Male to F Male

TV Connectors

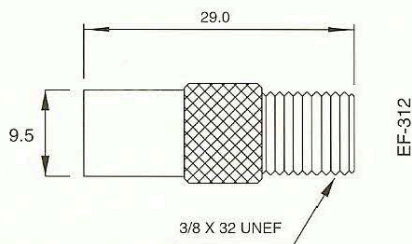
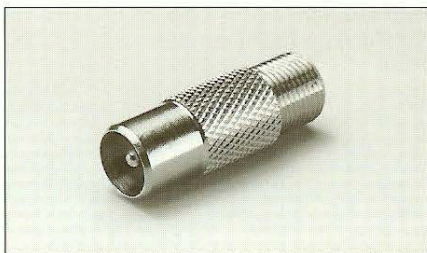

Part No. EF- 312
TV Male to F Female

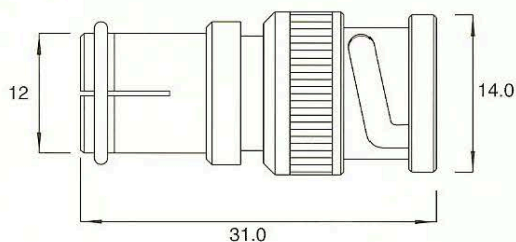

Part No. EB- 321
BNC Male to IEC Female

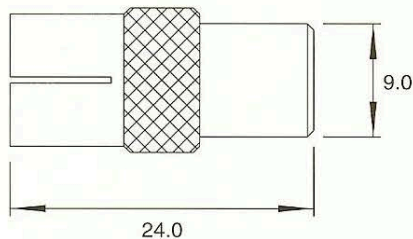

Part No. E312S-9.0
TV Male 9.0 to
TV Female - European

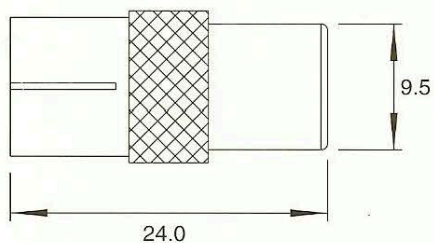

Part No. E312S
TV Male 9.5 to TV Female

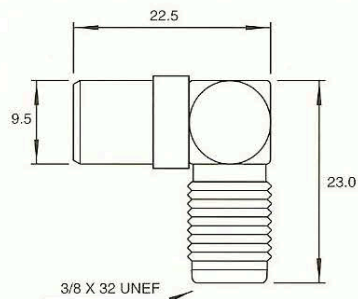

Part No. EF-412
TV Male to F Female - right angle

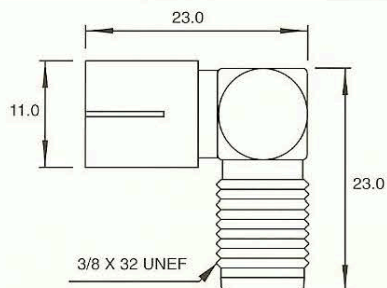
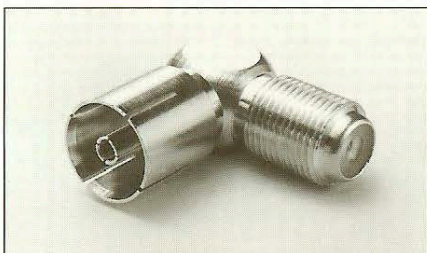

Part No. EF-422
TV Female to F Female, right angle

TV Connectors

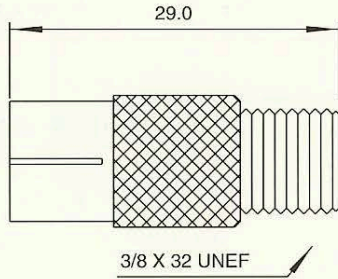
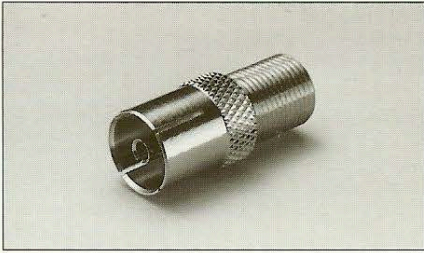

Part No. EF-322
TV Female to F Female

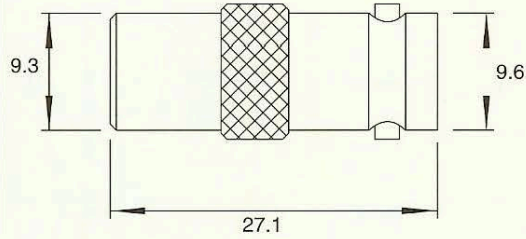
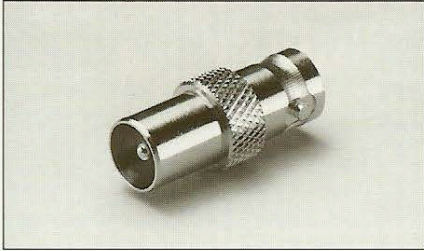

Part No. EB-312
BNC Female to TV Male

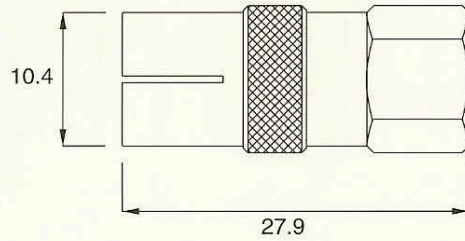
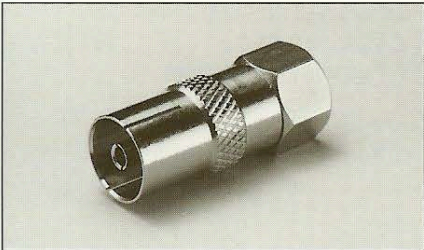

Part No. EF-321A
TV Female to F Male

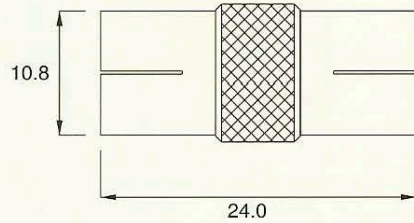
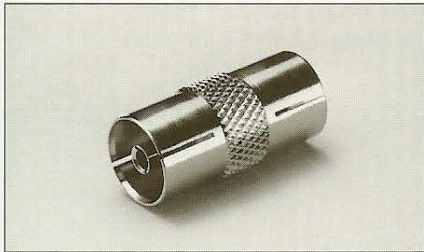

Part No. E-322
TV Female - double all metal

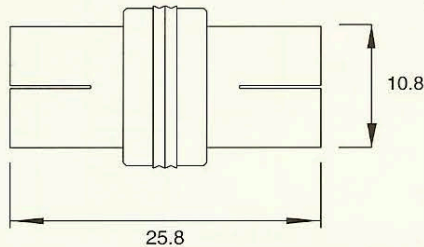
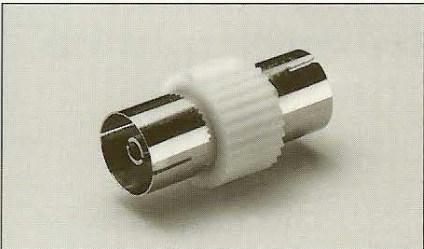

Part No. E-322-P
TV Female - double plastic

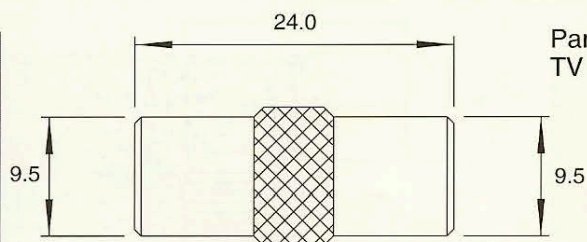
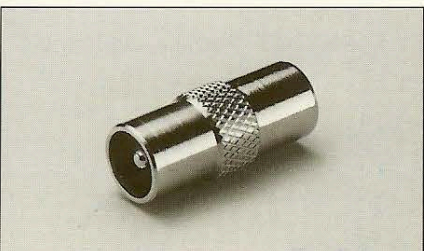

Part No. E-311
TV Male - double

TV Connectors

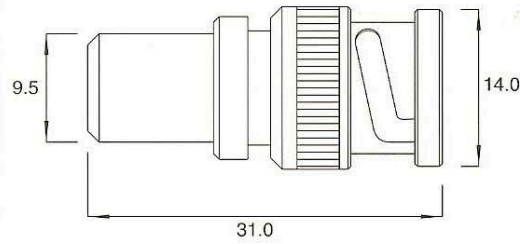
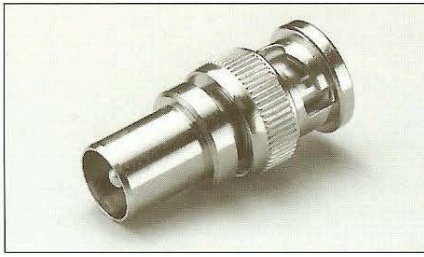

Part No. EB-311
TV Male to BNC Male

**If you require alternative configurations
or need custom designed
TV CONNECTOR ADAPTORS
Telephone our SALES OFFICE on
Tel: +44(0)1480 406206**

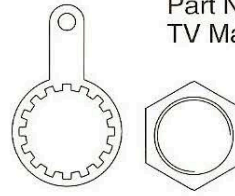
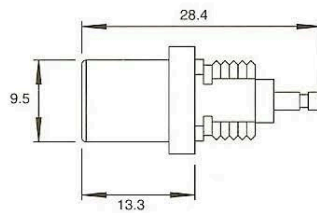

BULKHEAD MOUNT CONNECTORS

Part No. E 135
TV Male - solder

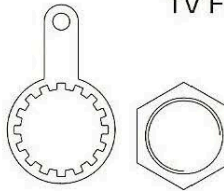
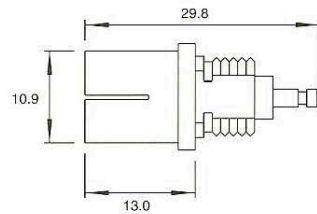

Part No. E 235
TV Female

**Also see SWAGE MOUNT CONNECTORS
on page 3**

**If you require alternative configurations
or need custom designed brackets or
BULKHEAD MOUNT CONNECTORS
Telephone our SALES OFFICE on
Tel: +44(0)1480406206**

CABLE GROUPS

To denote the cable group required add the following suffix to your Part No.

(e.g. TV Series Male Crimp Type for RG/59 Cable = E-114BG)

SUFFIX	CABLE TYPE - RG/U
A-	5.5A, 6.6A, 212, 222
B-	8.8A, 213
C-	9.9A, 9B, 214
D-	11, 11A
E-	22A, 22B
F-	58, 58A, 58C, 141, 141A
G-	59, 59A, 59B, 62, 62A, 62B, 62C, 210
H-	71, 71A, 71B
J-	108A
K-	55, 55B, 142B, 400
L-	174, 179A, 187, 188, 188A, 316
M-	178, 178A, 179B, 196, 196A
N-	179B, 187A,
P-	55A, 142, 142A, 223
Q-	BELDEN 8281
R-	BELDEN 8227 AND 9207